

C

NSA192004

Pages:4

Reg No.: \_\_\_\_\_

Name: \_\_\_\_\_

**APJ ABDUL KALAM TECHNOLOGICAL UNIVERSITY**  
FIRST SEMESTER B.TECH DEGREE EXAMINATION(2019 SCHEME), DECEMBER 2019

**Course Code: EST100**

**Course Name: ENGINEERING MECHANICS**

**(2019-Scheme)**

Max. Marks: 100

Duration: 3 Hours

**PART A**

*(Answer all questions, each carries 3 marks.)*

- 1 A ladder of weight 30 kg is supported at wall and floor as shown in fig 1 below. A man of weight 72 kg stands on it vertically, 8 m above the floor level. There is a 100 kg force acting at top-most point of the ladder vertically. The mass distribution of the ladder is uniform. Considering all contact surfaces smooth, draw the free body diagram. (3)

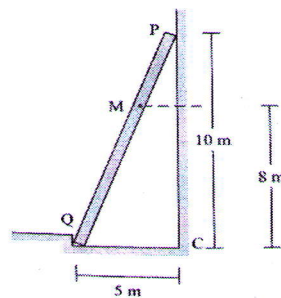

Fig 1

- 2 State and explain Varignon's theorem for concurrent coplanar forces. (3)
- 3 Briefly explain the analysis of forces acting on a wedge with a suitable example. (3)
- 4 A simply supported beam AB of span 4m is carrying point loads 10N, 6N & 4N at 1m, 2m & 3m respectively from support A. Calculate reactions at supports A and B. (3)
- 5 A force  $2i+4j-3k$  is applied at the point A(1,1,-2). Find the moment of the force about the point (2,-1,2) (3)
- 6 Calculate the area moment of inertia of a rectangular cross-section of breadth 'b' and depth 'd' about the centroidal horizontal axis. (3)
- 7 A body is projected at an angle such that its horizontal displacement is 3 times that of maximum height. Find the angle of projection. (3)
- 8 The position of a particle moving along a straight line is defined by the relation  $x = t^3 - 3t^2 - 9t + 12$  (3)  
Determine the time taken by the particle when its velocity becomes zero.
- 9 A flywheel weighing 500N and having radius of gyration 0.4 m loses its speed from 300rpm to 180 rpm in 1 minute. Calculate the torque acting on it. (3)
- 10 Distinguish damped and undamped free vibrations. (3)

## PART B

(Answer one full question from each module, each question carries 14 marks)

## Module-I

- 11 a) A rope 9m long is connected at A and B, two points on the same level, 8m apart. A load of 300N is suspended from a point C on the rope, 3m from A. What load connected to a point D, on the rope, 2m from B is necessary to keep portion CD parallel to AB. (5)
- b) Concurrent forces of 1,3,5,7,9,11 N are applied to the center of a regular hexagon acting towards its vertices as shown in fig 2. Determine the magnitude and direction of the resultant. (9)

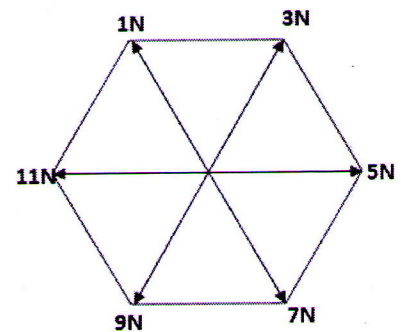

Fig 2

- 12 a) A uniform wheel 60 cm diameter weighing 1000 N rests against a rectangular obstacle 15 cm height as shown in fig 3. Find the least force required which when acting through the centre of the wheel will just turn the wheel over the corner of the block. (5)
- b) The system of connected flexible cables shown in Fig.4 is supporting two loads of 550 N and 600 N at points B and D, respectively. Determine the tensions in the various segments of the cable. (9)

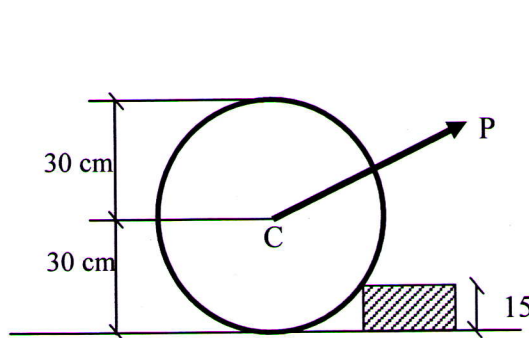

Fig 3

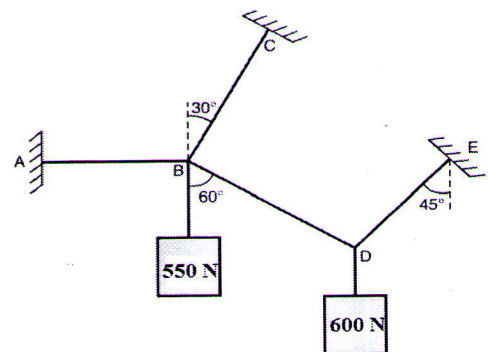

Fig 4

## Module-II

- 13 a) Find the force required to move a load of 30N up a rough inclined plane, applied parallel to the plane. The inclination of the plane is such that when the same body is kept on a perfectly smooth plane inclined at an angle, a force of 6N applied at an

inclination of  $30^\circ$  to the plane keeps the same in equilibrium. Assume coefficient of friction between the rough plane and the load is equal to 0.3.

- b) For the beam with loading shown in Fig.5, determine the reactions at the supports. (7)

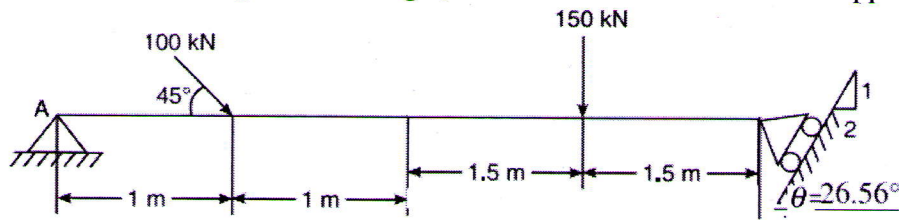
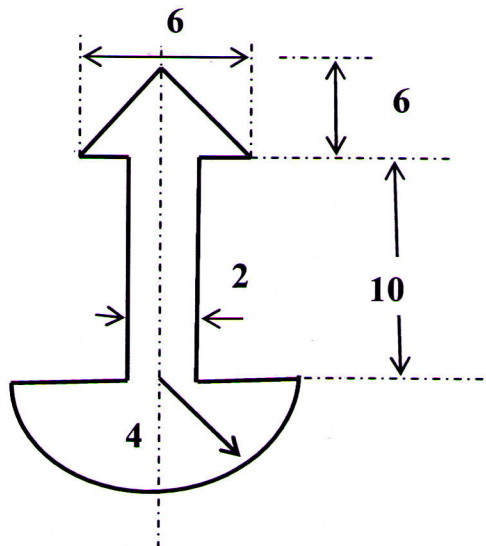

Fig.5

- 14 A uniform ladder 4 m long weighs 200 N. It is placed against a wall making an angle of  $60^\circ$  with the floor. The coefficient of friction between the wall and the ladder is 0.25 and that between the ground and the ladder is 0.35. The ladder in addition to its own weight, has to support a man of 1000 N at the top at B. Calculate: (i) The horizontal force  $P$  to be applied to the ladder at the ground level to prevent slipping. (ii) If the force  $P$  is not applied, what should be the minimum inclination of the ladder with the horizontal, so that it does not slip with the man at the top? (14)

**Module-III**

- 15 Find the moment of inertia of shaded area about the horizontal and vertical centroidal axis. All dimensions in cm. (14)



- 16 A force  $P$  is directed from a point  $A(4,1,4)$  meters towards a point  $B(-3,4,1)$  metres. (14)  
Determine the moment of force  $P$  about  $x$  and  $y$  axis if it produces a moment of 1000 Nm about  $z$  axis.

**Module-IV**

- 17 An object of mass 5 kg is projected with a velocity of 20 m/s at an angle of  $60^\circ$  to the horizontal. (14)  
At the highest point of its path the projectile explodes and breaks up into two fragments of masses 1 kg and 4 kg. The fragments separate horizontally after explosion. The explosion releases internal energy such that KE of the system at the highest point is doubled. Calculate the separation distance between two fragments when they reach the ground.



- 18 A block of mass  $M_1$  resting on an inclined plane is connected by a string and pulleys to another block of mass  $M_2$  as shown in Fig.7. Find the tension in the string and acceleration of the blocks. Assume the coefficient of friction between the blocks  $M_1$  and the plane to be 0.2.  $M_1 = 1500\text{N}$ ,  $M_2 = 1000\text{N}$ . Angle of inclined plane =  $45^\circ$ . (14)

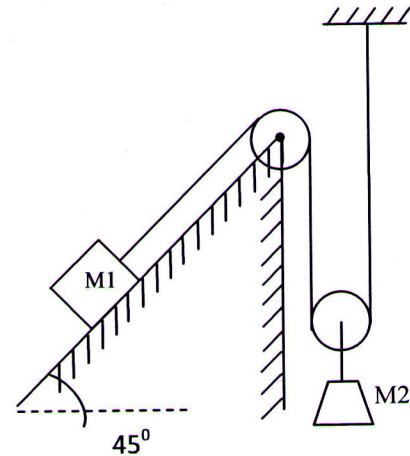

Fig 7

## Module-V

- 19 A rotor of an electric motor is uniformly accelerated to a speed of 1800 rpm from rest (14) for 5 seconds and then immediately power is switched off and the motor decelerates uniformly. If the total time elapsed from start to stop is 12.5 sec, determine the number of revolutions made while (a) acceleration (b) deceleration. Also find the value of deceleration.
- 20 a A spring stretches by 0.015m when a 1.75kg object is suspended from its end. How (5) much mass should be attached to the spring so that its frequency of vibration is 3 Hz.
- b A particle moving with simple harmonic motion has velocities 8m/s and 4m/s when (9) at the distance of 1m and 2m from the mean position. Determine (a) amplitude (b) period (c) maximum velocity, and (d) maximum acceleration of the particle.

\*\*\*\*